

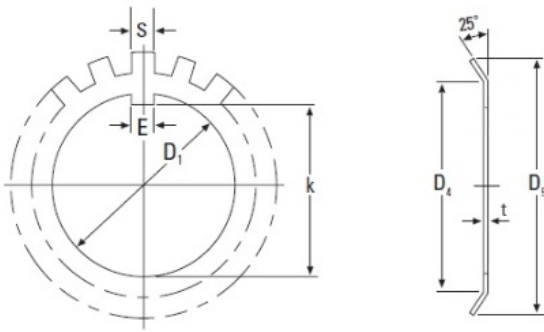

# NTN BEARING CORP.OF AMERICA



## Timken MB 15 Bearings

Bearing No. MB 15

D <sub>1</sub>	75 mm
k	71.5 mm
E	8 mm
t	1.5 mm
S	8 mm
D <sub>4</sub>	90 mm
D <sub>5</sub>	104 mm
No. of Tangs	19
Weight	36 g
Locknut	KM 15

MB 15 Bearing 2D drawings and 3D CAD models